



Installation Instructions for the Detachable Cable Ends



Detachable End with SK-301 Cable

SK-4300 MicroMini Retractor w/Detachable End



SK-44TD Teardrop Retractor w/Detachable End

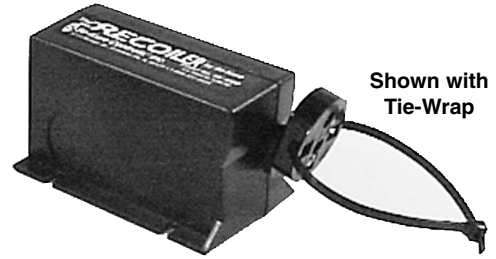

SK-4500 Standard Recoiler w/Detachable End

Shown with Tie-Wrap

Accessories



SK-943T Tie-Wrap

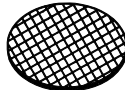

SK-1709 1-1/4" Round Adhesive

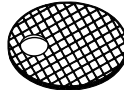

SK-1709-3 1-1/4" Round Adhesive

With Tripod Security Screw Hole



SK-11-151 Security Screw



SKP-200K Security Allen Wrench

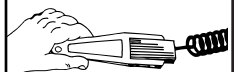

SK-1912 Removal Tool

Easy Installation:

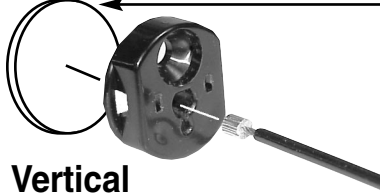

Vertical

SK-1709 1-1/4" Round Adhesive

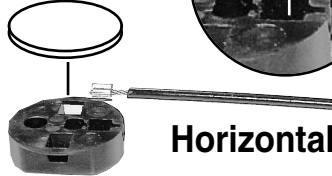

Horizontal

Connect the Detachable Vertically or Horizontally:

1. Push the detachable cable stop through the hole in the detachable end (for vertical attachment) and "hook" the stop onto the end to secure. - Or - Place the stop with cable "bridging" through the slot in the detachable end (for horizontal attachment).
2. Remove the backing sheet from the SK-1709 round adhesive. Press the adhesive into place on the detachable end to trap the stop inside.

Special Note: Before applying adhesive, clean the surface on the detachable end and the product you are going to apply it to with Alcohol Prep Pads and dry the surface area with a clean paper towel or rag.

3. Remove the 2nd backing sheet; press the detachable end onto a cleaned surface on the product to be protected.

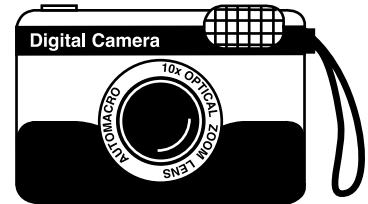

Digital Camera

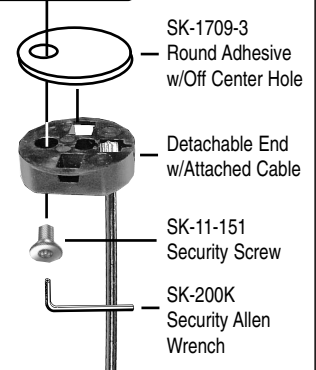

SK-1709-3 Round Adhesive w/Off Center Hole

Detachable End w/Attached Cable

SK-11-151 Security Screw

SKP-200K Security Allen Wrench

Connect to the Camera Tripod Mount:

1. Push the SK-1842 Tripod Security Screw through the hole in the end and up through the camera tripod mounting hole. Tighten with the SKP-200K Allen Wrench.

Caution: Do Not Over tighten the tripod security screw or you could damage the camera's tripod mounting hole.



Se-Kure Controls, Inc.

On the Web: www.se-kure.com
E-Mail: sekure@msn.com

3714 Runge Street • Franklin Park, IL 60131 • 1-(800) 322-2435 • (847) 288-1111 • Fax: (847) 288-9999

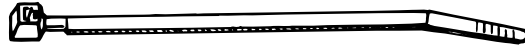

SK-943T
Tie-Wrap



Attaching the SK-943T Tie-Wrap to Detachable Ends Provides Additional Strength Between The Cable End & Display Product.

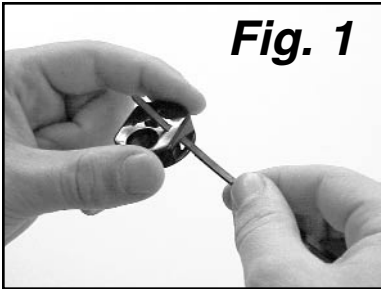

Fig. 1

1. Push the leading edge of the SK-943T Tie-Wrap through the hole in the side of the detachable end, and out the back, as shown in Fig. 1 at left.

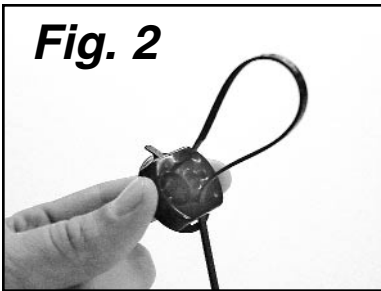

Fig. 2

2. Reinsert the leading edge of the Tie-Wrap into the other hole in the back, and allow it to pass through the hole on the side, as shown in Fig. 2 at left.

3. The Tie-Wrap can now be wrapped around the display product. Insert the leading edge into its locking mechanism and pull the tie-wrap tight.

4. Cut off any excess tie-wrap just after the tie-wrap lock.



Se-Kure Controls,® Inc.

On the Web: www.se-kure.com
E-Mail: sekure@msn.com

3714 Runge Street • Franklin Park, IL 60131 • 1-(800) 322-2435 • (847) 288-1111 • Fax: (847) 288-9999